

MESS MATIC

Rev.010908

SIRION LX ECO

COMPUTERIZED OFF-THE-CAR WHEEL BALANCER

GB

OPERATING INSTRUCTIONS



**TEKNİK BALANS
MAKİNA SANAYİ
VE TİCARET AŞ.**



ATATÜRK ORGANİZE SANAYİ BÖLGESİ, 10001 SOKAK NO:15 35620 CIGLI-IZMIR-TURKIYE
TEL. : (00-90-232) 376 84 40 – PBX FAX. : (00-90-232) 376 84 39

www.messmatic.com.tr

INDEX	P.NO
1. CAUTION	4
1.1. Preliminary Safety Information	4
2. GENERAL INFORMATION	4
3. OPERATOR TRAINING	6
3.1. General Preventive Measures	6
4. SAFETY PARTS	7
5. TECHNICAL DATA	7
6. OVERALL DIMENSIONS	8
7. TRANSPORT AND INSTALLATION	9
7.1. Transport and Unpacking	9
7.2. Installation	10
7.2.1. Fitting the adapter	10
7.2.2 Power Connections	11
8. MOUNTING THE WHEEL ON THE SHAFT	11
8.1. Wheel mounting	11
9. SWITCHING THE MACHINE ON/OFF	12
10. WHEEL BALANCING	13
10.1. Determination of Wheel Dimensions	13
10.1.1. Automatic wheel dimension setting	13
10.1.2. Manual setting of wheel dimensions	17
10.2 Multi User Programme	17
10.3. Balancing Procedure	18
10.3.1. Dynamic balancing	18
10.3.2. Applying the weights	20
10.4. Increasing/Decreasing the Weight Resolution	21
10.5. Alu/Static Unbalance Measurement	22
10.5.1. Alu-S / Alu-S1 procedures	22
10.5.2. Specific programs for alloy rims (Alu 1-2-3-4)	26
10.5.2.1. Alu-1 Procedure	27
10.5.3. Static balancing procedure	29

INDEX	P.NO
11. HIDDEN WEIGHT BEHIND SPOKES	34
12. RIM-TYRE OPTIMIZATION	37
13. OPTIONS SETUP, UNITS OF MEASUREMENT	39
13.1. User Menu for Options Setup	39
14. CALIBRATION	41
14.1. Weight (gram) Calibration	42
14.2. Mechanic System Unbalance Compensation	45
14.3. Distance/Diameter Gauge Calibration	47
14.3.1. Calibration for distance	48
14.3.2. Calibration for diameter	50
15. MAINTENANCE	52
16. BALANCING EQUIPMENT EFFICIENCY	53

1. CAUTION

Any damage caused by failure to follow the instructions in this manual or improper machine use shall relieve Teknik Balans A.Ş. of all liability.

1.1. PRELIMINARY SAFETY INFORMATION

Before starting the machine :

- Read the instructions and the entire manual before using or working on the wheel balancer. This manual represents an integral part of the product and is intended to inform the user on how to use the wheel balancer. Look after the manual for the entire life of the machine. Keep it in an easy to access place and refer to it every time the need arises. All machine operators must be able to read the manual.
- Make sure the power supply is in conformity with the specifications shown on the plate.
- Make sure the machine is properly positioned on the floor.
- Suitably position the machine power cables.

On starting the machine :

- Remove any foreign bodies from the tyre before spinning the wheel.
- Always use the protection guard and do not touch the wheel when reading measurements.
- Make sure the counterweights are fitted properly before spinning the wheel again.

In emergency conditions and before performing any maintenance :

- Isolate the machine from any power sources by means of the machine master switch.

Work environment and machine cleaning :

- The work environment must be kept clean and dry and must not be exposed to atmospheric agents. It must be also well lit.
- Do not clean the machine using strong jets of water and compressed air.
- To clean plastic panels or tops, use alcohol (always avoid liquids containing solvents).

2. GENERAL INFORMATION

Sirion Series wheel balancers are designed to balance wheel of cars, motorcycle and light commercial vans with rims width from 1.5” to 20” and diameter from 10” to 24”.

Any other use is improper and therefore not authorised.

3. OPERATOR TRAINING

The use of this machine is reserved to specially trained and authorised personnel.

Any unauthorised changes or modifications to the machine, in particular to its electric system, relieve Teknik Balans A.Ş. from all liability.



Exclusively professionally qualified personnel must do any work, however minor, on the electric system.

3.1. GENERAL PREVENTIVE MEASURES

- During operation and maintenance of this machine, always abide by the safety and accident-prevention regulations in force.
- The machine must only be used by adequately trained and authorised persons.
- **UNDER NO CIRCUMSTANCES** must the machine be used to spin anything but vehicle wheels. Bad locking can cause rotating parts to become loose, with potential damage to the machine and anything in the vicinity and injury to the operator.
- This machine must only be used for the purpose for which it was expressly intended. Teknik Balans A.Ş. declines all liability for injury or damage to persons, animals and things caused by improper machine use.
- Accessories and spare parts must be fitted by persons authorised by Teknik Balans A.Ş., and only original spare parts and accessories must be used.
- The machine must only be operated in places where there is no danger of explosions or fire.
- Removal or changes made to safety devices, or warning signals on the machine can cause serious hazards and represents a violation of European safety regulations.
- Before doing any maintenance jobs on the system, always disconnect the power supply. In case of doubt, do not interpret, but contact Teknik Balans A.Ş. technical assistance in order to obtain instructions suitable for performing operations in total safety.
- Wheel balancer operators must not wear loose clothing, hanging ties, chains or other accessories that could become trapped. Long hair should be properly collected up and tied or protected.
- Do not allow unauthorised personnel to come near the wheel balancer during the cycle.
- Close the protection guard when performing a measuring cycle. Such cycle will not in fact start unless the guard is closed.

4. SAFETY PARTS

The wheel balancer is equipped with a number of safety devices. One of these is located on the rear side of the machine (master switch). The master switch interrupts power to the machine when turned to “0”.

Wheel spinning is normally prevented if the wheel protection guard is raised (open)(only for Sirion LX and Sirion not for Sirion ECO). When the protection guard is open, this interrupts the circuit that triggers the motor and automatic start is prevented, including in the case of an error.

Press STOP key on the keyboard to stop the wheel in emergency conditions.

5. TECHICAL DATA

Rim Diameter	10"-24"
Rim Width	1,5" – 20"
Max.wheel weight	65 kg.
Power supply	230 V., 1 phase, 50/60 Hz.
Balancing speed	99 rpm
Balancing accuracy	1 gr.
Type of display unit	17 " TFT monitor (Sirion LX) 17 " SVGA monitor (Sirion & Sirion ECO)

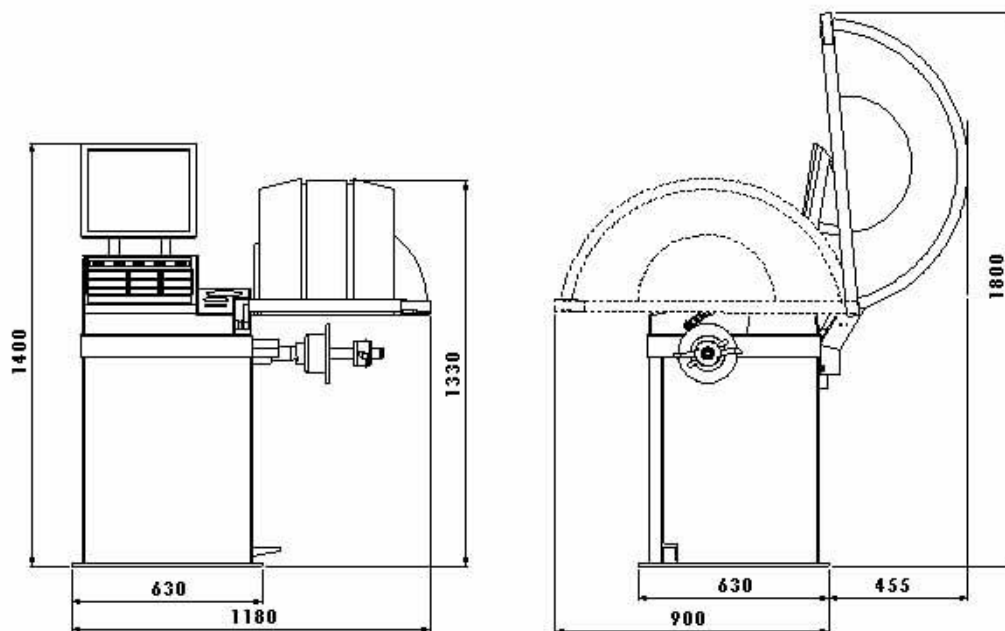
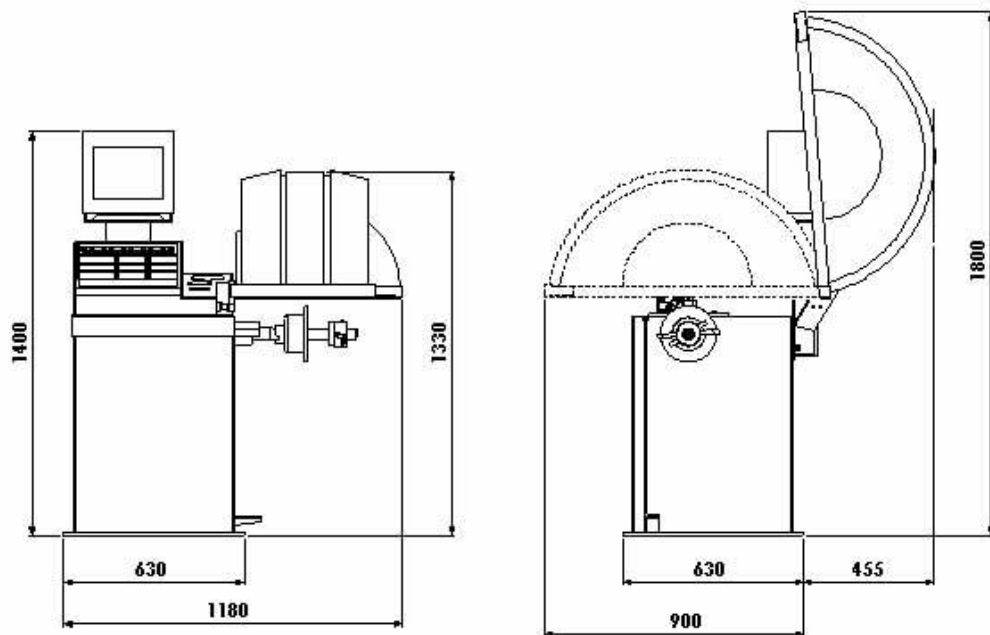
6. OVERALL DIMENSIONS**SIRION LX****SIRION & SIRION ECO**

7. TRANSPORT AND INSTALLATION

7.1. TRANSPORT AND UNPACKING

Depending on customer request, the machine is delivered in 2 packing versions :

1. In pallet
2. No packing

To transport the machine to the point where it is to be installed, use a lifting and transport mechanism such as a fork-lift truck or lift with forks.

The lifting device must have a fitting capacity equal at least to the weight of the packed machine. During transport, prevent the lifted machine from swinging.

The machine must be stored in its packing, in a dry and ventilated environment (with a temperature between -25° $+55^{\circ}$)

Never overturn or position the packing horizontally. The pallet must always rest on a flat and solid surface. Do not stack other packages on top of the packaging.

DURING UNPACKING, ALWAYS WEAR GLOVES TO PREVENT ANY INJURY CAUSED BY CONTACT WITH PACKAGING MATERIAL (NAILS, ETC.).

The packaging material (plastic bags, polystyrene, nails, screws, wood, etc.) must be collected up and disposed of through authorised channels, except for the pallet, which could be used again for subsequent machine handling.

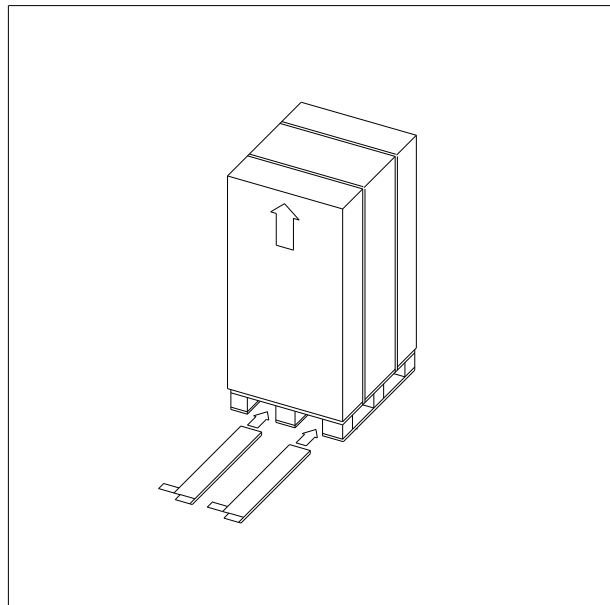

7.2. INSTALLATION

Position the wheel balancer where this is to be used.

Never lift the machine by means of the shaft.

Install the machine in a dry, covered and well-lit place, possibly closed or protected against the elements. Before positioning the machine, make sure the place chosen complies with applicable safety regulations and check the minimum distances from walls or other obstacles.

The position must be such as to allow the operator to see the area around the machine. During operation in fact, the operator must make sure there is no one or nothing in the vicinity of the machine that could represent a hazard.

Ambient conditions in the operating place must be maintained within the following limits :

*Relative humidity 30% - 90%

*Temperature range 0° - 45°

The wheel balancer can operate on any solid and flat surface.

Make sure the base of the machine is resting properly on the floor and if necessary shim.

The machine is best secured to the floor at the 4 anchor points. Anchoring is mandatory if wheels weighing more than 30 kg. are used.

7.2.1. FITTING THE ADAPTER

Tighten the adapter by using Allen wrench (supplied with the machine).



7.2.2. POWER CONNECTIONS

Before making any power connections, carefully check :

- power line specifications correspond to machine requirements as shown on the machine plate.
- there is an earth lead and this is of suitable size.
- that all the component parts of the power line are in good condition.
- that a wall switch exists solely for starting and stopping the machine. This must feature a residual current and thermal magnetic circuit breaker, taking into account the electrical power indicated on the wheel balancer.

Connect the machine up to the mains by means of the 3-pole plug provided (230 V., single phase) through the wall socket. If the plug provided is not suitable for the wall socket, fit a plug that complies with local and applicable regulations. This operation must be performed by expert and professional personnel.

IT IS ABSOLUTELY ESSENTIAL THAT THE SYSTEM IS EQUIPPED WITH A GOOD GROUNDING CIRCUIT.

8. MOUNTING THE WHEEL ON THE SHAFT

8.1. WHEEL MOUNTING

To achieve perfect balancing, the wheel must be carefully and properly fitted on the shaft. Imperfect centring will inevitably cause unbalances.

The wheel mounting on the wheel balancer is shown below :

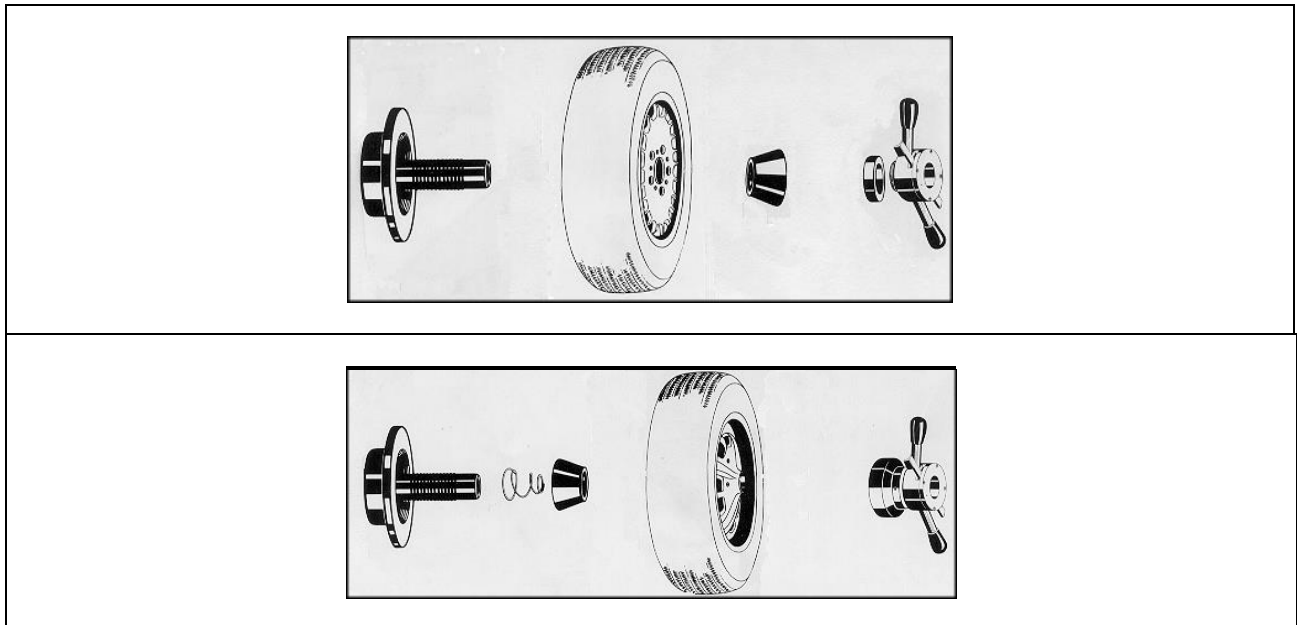



9. SWITCHING THE MACHINE ON AND OFF





Switch-on the balancer from the master switch on the back side of the machine. Wait a few seconds for the operating program to load and the first program page to appear on the screen.



Figure -1-

By means of the 5 circle-shaped buttons located on the bottom of the screen, all the machine functions can be controlled. During program running, the various display pages show the different buttons by means of which the corresponding function can be immediately selected.

Many display pages contain several rows of buttons. To go back and display the previous page, press the button corresponding to the icon , to go ahead and display the next page, press the button corresponding to the icon .

ICON	DESCRIPTION
	Displays service and configuration pages
	Displays multi-user program page (see in page 12)
	Blank button (has no function)
	Displays wheel dimension page (see in page 10)
	Wheel spin performed if wheel guard is closed.

10. WHEEL BALANCING

10.1. DETERMINATION OF WHEEL DIMENSIONS

10.1.1. Automatic wheel dimension setting (distance and diameter)

The SIRION LX and SIRION (not for SIRION ECO) wheel balancers feature an automatic gauge; a simple and precise method for the automatic acquisition of the distance from the machine and the wheel diameter at the weight application point. The gauge permits correctly positioning the weights inside the wheel by pressing the pedal brake.

To perform a measurement in Dynamic mode :



Pull out the automatic gauge. The program will switch from the initial page (Fig.-1-) to the page shown below (Fig.-2-)

**Figure -2-**

Move the gauge against the inner edge and maintain the position for a few seconds. Indication of the acquired measurement is given by means of the colour change of numbers from red to orange and a “beep” signal will be heard to confirm the acquired measurement.



The cursor automatically moves on the width value where its colour turned to red.

The nominal width is indicated on the rim, but it is recommended to use graduated gauge by positioning it on the outer and inner side of the wheel as shown in Figure -3- and then determine the measurement to be set.

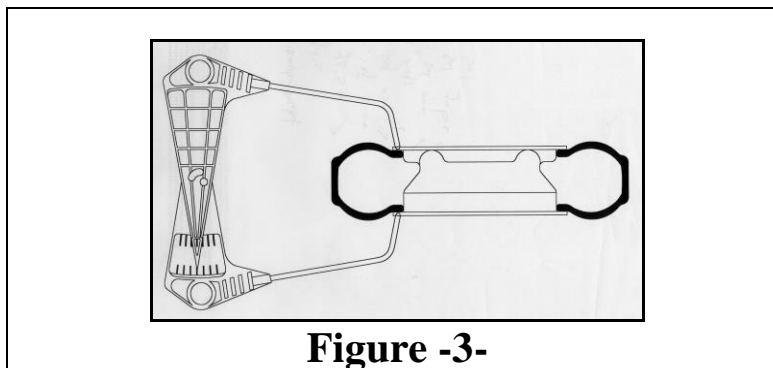
Set the width manually by using  and .

**Figure -3-**

To perform a measurement in ALU-S and ALU-S1 modes :

On wheel dimension page (Fig.-2-), press the  in order to select  icon on the screen. The chosen icon's color becomes red. Then, press  in order to set it from Dynamic to Alu-S or Alu-S1 (Fig.-4/4a-).

**Figure -4-****Figure -4a-**

Alu-S mode is used to apply adhesive weights for both planes (inside-outside). **Alu-S1** mode is used to apply clip-on weight for the 1st plane (inside) and adhesive weight for the 2nd plane (outside).



For **Alu-S** mode, take out the automatic gauge and reach the 1st position to be stored. Keep this position for a few seconds. Indication of the acquired measurement for the first point is shown by the numbers that switches from red to orange and a “beep” signal will be heard to confirm the acquired measurement. Without returning the gauge to initial position, pull the automatic gauge further out and reach the 2nd position to be stored. Keep this position for a few seconds. Indication of the acquired measurement for the first point is shown by the numbers that switches from red to orange and a “beep” signal will be heard to confirm the acquired measurement.

In this case, the width is automatically stored. Do not change this value.

For **Alu-S1** mode, move the gauge against the inner edge and maintain the position for a few seconds. Indication of the acquired measurement is given by means of the color change of numbers from red to orange and a “beep” signal will be heard to confirm the acquired measurement. Without returning the gauge to initial position, pull the automatic gauge further out and reach the 2nd position where the adhesive weight will be applied. Keep this position for a few seconds. Indication of the acquired measurement for the first point is shown by the numbers that switches from red to orange and a “beep” signal will be heard to confirm the acquired measurement.

In this case, the width is automatically stored. Do not change this value.



To perform a measurement in ALU-1, ALU-2, ALU-3 VE ALU-4 modes :

On wheel dimension page (Fig.-2-), press the  in order to select  icon on the screen. The chosen icon's color becomes red. Then, press  in order to set it from Dynamic to desired Alu modes (e.g., Alu-3, Fig.-4b-).



**Figure -4b-**

Take out the automatic gauge and reach the 1st position to be stored. Keep this position for a few seconds. Indication of the acquired measurement for the first point is shown by the numbers that switches from red to orange and a “beep” signal will be heard to confirm the acquired measurement. The second weight positioning point is calculated by the machine (inside the rim).

The cursor automatically moves on the width value where its colour turned to red. The nominal width is indicated on the rim, but it is recommended to use graduated gauge by positioning it on the outer and inner side of the wheel as shown in Figure -3- and then determine the measurement to be set.

Set the width manually by using  and .

To perform a measurement in Static-1 and Static-2 mode :



On wheel dimension page (Fig.-2-), press the  in order to select  icon on the screen. The chosen icon's color becomes red. Then, press  in order to choose the mode to be used (e.g. Static-1, Fig.-4c-).

**Figure -4c-**

Take out the automatic gauge and reach the position to be stored. Keep this position for a few seconds. Indication of the acquired measurement shown by the numbers that switches from red to orange and a “beep” signal will be heard to confirm the acquired measurement.

10.1.2. Manual setting of wheel dimensions

SIRION ECO model wheel balancer has no automatic gauge. Thus, the wheel dimensions must be entered manually by the operator.

While you are on wheel dimension page (Fig.-2-), press the  button to select the figure (selected figure colour changes and becomes red) and change or set it by pressing  and  buttons.

10.2. MULTI USER PROGRAMME

To select multi-user program, select the  on the presentation page (Fig.-1-).

Sirion Series wheel balancers can be used by 4 different users at the same time, by selecting the above mentioned button. On the multi-user page (Fig.-5-), by pressing numbers 1 to 4, you can choose the desired user.

The system stores the data relating to the last performed spin according to the different operators. The desired user can be called every time the program displays the specific button.

**Figure -5-**

10.3. BALANCING PROCEDURE**10.3.1. DYNAMIC BALANCING**

Dynamic balancing is a procedure that offsets the wheel vibrations using 2 weights on different planes.

To perform a dynamic measurement spin :

- Make sure the wheel is clean of any stones and/or mud.
- Remove any counterweights.
- Fit the wheel and make sure it is fastened properly
- Enter the wheel measurements and close the protection guard to perform the automatic wheel spin
- If the protection guard is already closed, press the  button to perform wheel spin manually.



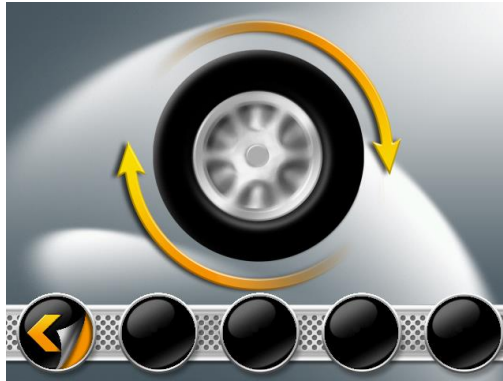
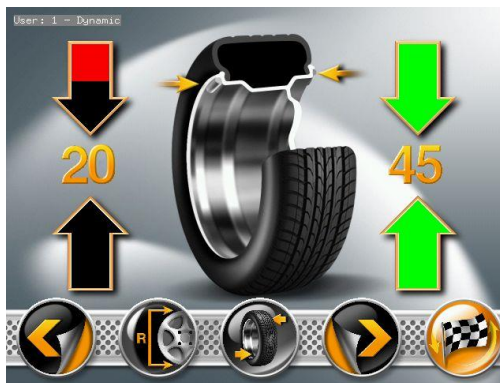

Note : If you press  while the wheel guard is not closed (lowered), the program shows the warning page (Fig.-6-) and reminds you that you must close the wheel guard for wheel spin.

**Figure -6-**

- In just a few seconds, the wheel runs at normal speed and the display screen shows wheel rotation (Fig.-7-)
- After the spin, the wheel stops automatically, taking into account the measured unbalance so that the fitting position of the outer weight is at about 12 o'clock. Open the wheel guard.
- The display unit indicates the direction in which to move the wheel to fit the weights and how much weight is needed to correct the unbalance (Fig.-8-)

**Figure -7-****Figure -8-**

- Weight can be determined in “grams” or “ounces”; in this manual examples are shown in grams.
- Once the unbalance of the inside and outside of the wheel is known, it is possible to proceed with positioning for correction of unbalance
- The display unit indicates the direction in which to move the wheel to fit the weights and how much weight is needed to correct the unbalance (Fig.-8-)

ICON	DESCRIPTION
	Return to previous page
	Enters wheel dimension page
	Automatic positioning of inner/outer unbalance point
	Displays next rows of buttons (optimization, split procedures)
	Wheel spin performed if wheel guard is closed.

10.3.2. APPLYING THE WEIGHTS

1. To find the position for the weights, turn the wheel until both the position search arrows become green, first on one side and then on the other.
2. Apply the weights, on the top of the rim, at 12 o'clock, indicated by the machine on the inside and outside of the wheel.

Once you have attached the balancing weights, make a test spin to check your results.

If O.K. messages appears (Fig.-9-), it means that perfect balance has been done successfully.

If at the end of the spin the displays do not show O.K. but, rather a residual unbalance, DO NOT USE ANOTHER WEIGHT, but follow the instructions below:

- A. Turn the wheel and find the exact position of the residual unbalance.
- B. Look the position of the previously applied weight and follow instructions in Fig.-10- , namely:
 - If the weight is in position 1, it means that it is too light. Replace it with a heavier one.
 - If the weight is in position 2, it means that it is too heavy. Replace it with lighter one.
 - If the weight is either 3 or 4, it means that it is improperly positioned. Just move it 1 or 2 cm. upwards.

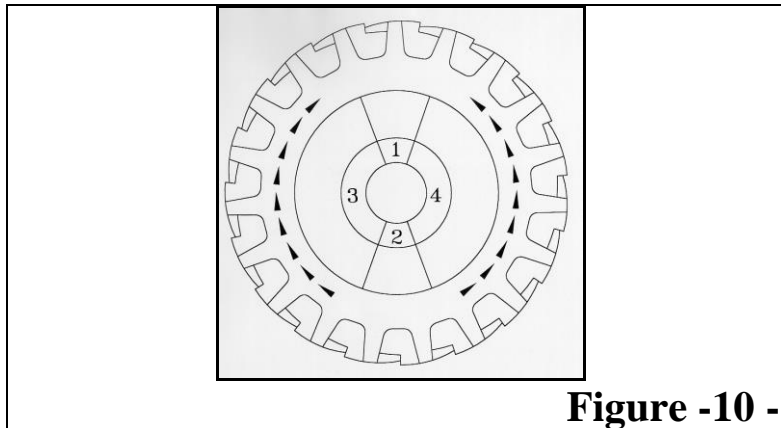

Spin the wheel and check the position again.

**Figure -9-**



10.4. INCREASING/DECREASING THE WEIGHT RESOLUTION



The weight resolution shown on the display screen can be normally set at 5 g or else 1g (this means either 5g, 10g, 15g, etc. or 1g, 2g, 3g, etc.) Correction weights below a certain limit are normally displayed as zero.

At the end of the spin (Fig.-8-), press the button corresponding to the icon  to display the next row of buttons (Fig.-11). On this page by pressing the button corresponding to the icon , the weight can be displayed with max.resolution of 1g, not considering the lower limit set.







10.5. ALU / STATIC UNBALANCE MEASUREMENT

Sirion Series have different ALU programmes for balancing of alloy wheels.

ALU-S, ALU-S1 (automatic for Sirion LX and Sirion models), **ALU 1,2,3,4, STATIC** : On wheel dimension page (Fig.-2-), press the  in order to select  icon on the screen. The chosen icon's color becomes red. Then, press  in order to set it from Dynamic to Alu-S, Alu-S1 and/or other different Alu programmes and/or Static program and/or PAX program.

10.5.1. ALU-S / ALU-S1 PROCEDURE (SIRION LX & SIRION)

Alu-S mode is used to apply adhesive weights for both planes (inside-outside). **Alu-S1** mode is used to apply clip-on weight for the 1st plane (inside) and adhesive weight for the 2nd plane (outside).

- Make sure the wheel is clean of any stones and/or mud.
- Remove any counterweights.
- Fit the wheel and make sure it is fastened properly
- From the initial display page (Fig.-1-), press  in order to enter wheel dimension page.
On this page (Fig.-2-), press the  in order to select  icon on the screen. The chosen icon's color becomes red. Then, press  in order to set it from Dynamic to Alu-S or Alu-S1 (Fig.-4/4a-).
- Determine the dimensions of the wheel using the automatic gauge provided (described on pages 11-12)
- After the data have been entered, close the protection guard to perform the wheel spin.
- If the protection guard is already closed, press the  button to perform wheel spin manually.

Note : If you press  while the wheel guard is not closed (lowered), the program shows a warning page (Fig.-12-) and reminds you that you must close the wheel guard for wheel spin.

**Figure -12-**

- In just a few seconds, the wheel runs at normal speed and the display screen shows wheel rotation (Fig.-13-)
- After the spin, the wheel stops automatically, taking into account the measured unbalance so that the fitting position of the outer weight is at about 12 o'clock. Open the wheel guard.
- The display unit indicates the direction in which to move the wheel to fit the weights and how much weight is needed to correct the unbalance (Fig.-14/14a-)

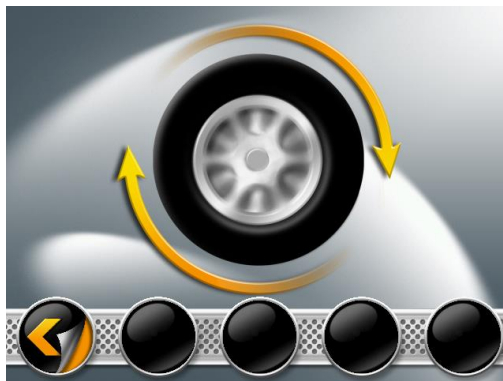
**Figure -13-**

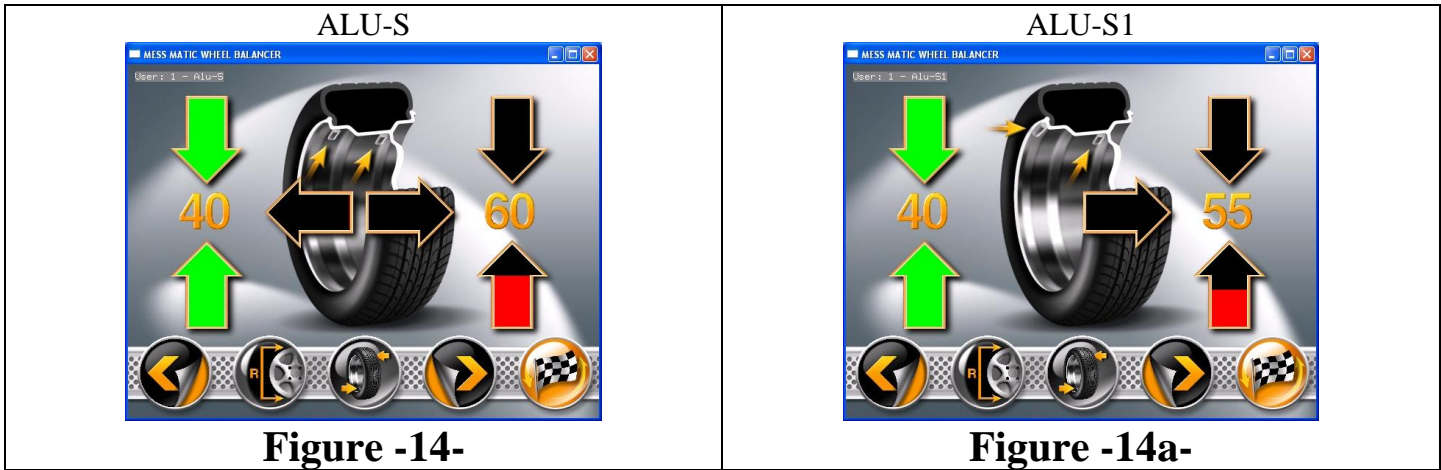

Figure -14-

Figure -14a-

- Once the unbalance of the inside and outside of the wheel is known, the wheel can be positioned by turning it in the direction indicated by the arrows until the correct position is reached.
- Once correct position has been reached, press the pedal brake to stop the wheel.

ICON	DESCRIPTION
	Return to previous page
	Enters wheel dimension page (see in page 10)
	Automatic positioning of inner unbalance
	Displays next rows of buttons (optimization, split procedures)
	Wheel spin performed if wheel guard is closed.

Application of the weight for the Internal Plane with **ALU-S Mode** :

- Remove the automatic gauge and fit the adhesive weight in the pliers (e.g., 40 gr., Figure 14) as shown in Fig.-15-.



Figure -15-



Figure -16-

- The weight correction position for the inner plane is indicated by horizontally positioned arrow in the center of the screen (Fig.-14-)
- Move the gauge inside the rim in order to reach first position. When the corresponded horizontally positioned arrow becomes in green, fit the weight in the position where the weight pliers touch the wheel (Fig.-16-). The indication of the exact position of the weight is accompanied by a “beep” sound.
- The fact that the weight fitting position is no longer at 12 o’clock (Fig.-16-) is automatically offset.

Application of the weight for the Internal Plane with **ALU-S1 Mode** ;

- To find the position for the internal plane, turn the wheel until both the position search arrows become green (Fig.14a).
- Apply the clip-on weight on the top of the rim, at 12 o’clock, indicated by the machine (e.g., 40 gr., Fig.14a) on the inside the wheel.

Application of the weight for the Outer Plane with **ALU-S and ALU-S1 Modes** ;

- Remove the automatic gauge and fit the adhesive weight in the pliers as shown in Fig.-15-.
- To find the position for the outer plane, turn the wheel until both the position search arrows become green.
- The weight correction positions are indicated by two horizontally positioned arrows in the center of the screen (Fig.-14/14a)
- Move the gauge inside the rim in order to reach the position for outer plane. When the corresponded horizontally positioned arrow becomes in green, fit the weight in the position where the weight pliers touch the wheel (Fig.-16-). The indication of the exact position of the weight is accompanied by a “beep” sound.
- The fact that the weight fitting position is no longer at 12 o’clock (Fig.-16-) is automatically offset.
- Repeat the wheel and weight positioning procedure for the other side (second position) of the wheel as well.
- At the end of the procedure, the wheel balancing conditions can be checked by performing a trial spin.

The ALU-S and ALU-S1 procedures are now completed.

10.5.2. SPECIFIC PROGRAMS FOR ALLOY RIMS (ALU 1-2-3-4)

These are four programs developed for the various types of aluminium rims. The positions of the weights in the four programs are shown in the following figures. Values are in inches, with the figures in millimetres in brackets.

IMPORTANT

For SIRION LX and SIRION Models, application of the adhesive weight is guided by the automatic gauge. If you prefer to apply adhesive weight manually by your hand and exactly at 12 o’clock position, please get in contact with your local technical service in order to change the relevant parameter.

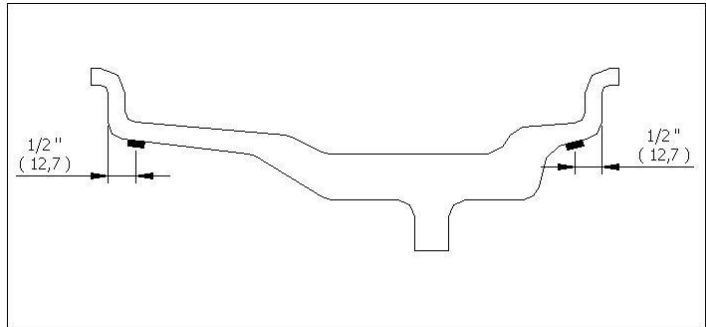
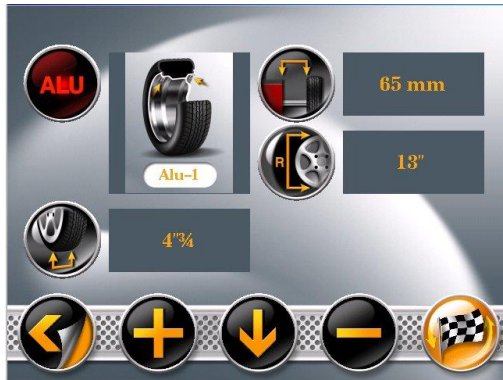

ALU -1

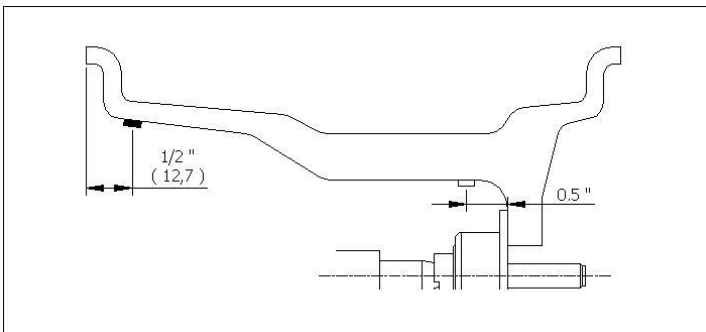
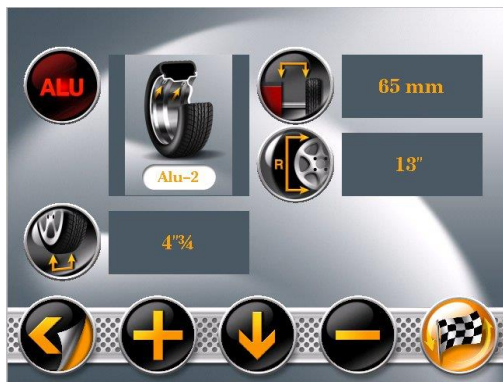

ALU -2

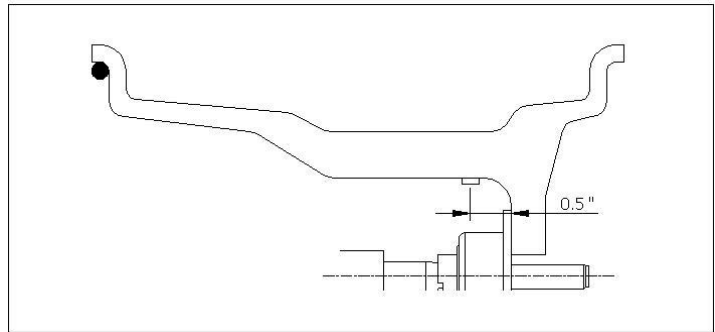
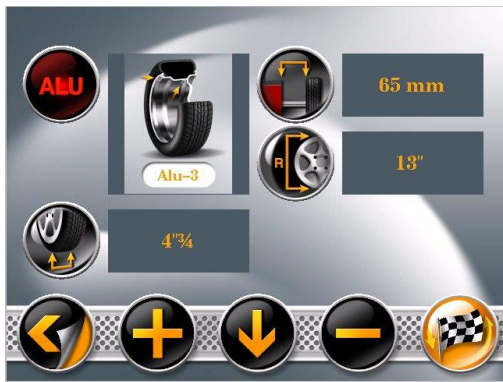

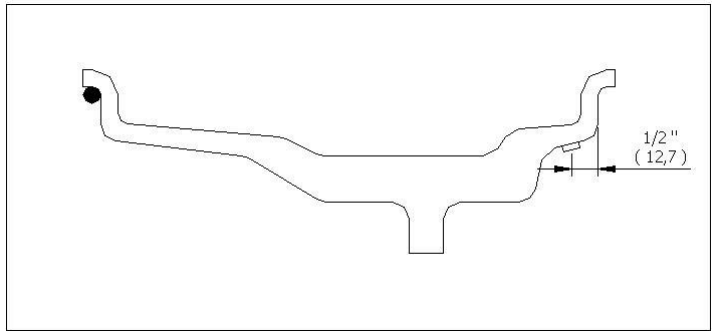
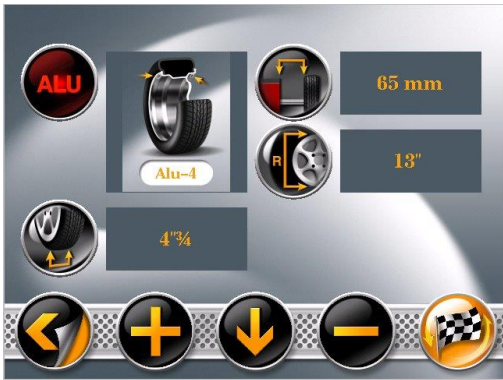

ALU -3



ALU -4

10.5.2.1 ALU-1 PROCEDURE



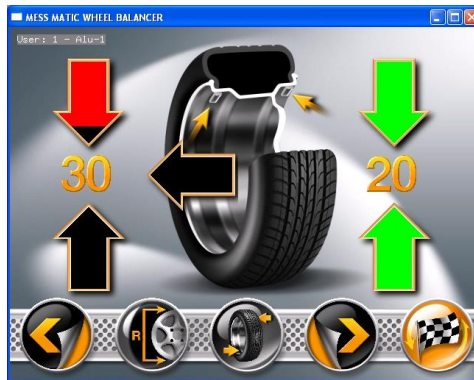

- On wheel dimension page (Fig.-2-), press the  in order to select  icon on the screen. The chosen icon's color becomes red. Then, press  in order to set it from Dynamic to Alu-1.
- Determine the dimensions of the wheel using the automatic gauge (page 12).
- Close the wheel guard to start wheel spin.
- In just a few seconds, the wheel runs at normal speed and the display screen shows wheel rotation (Fig.-13-)
- After the spin, the wheel stops automatically, taking into account the measured unbalance so that the fitting position of the outer weight is at about 12 o'clock. Open the wheel guard.
- The monitor shows the weight required to correct the unbalance (Figure -16a-)

**Figure -16a-**

- To find the position for the outer plane, turn the wheel until both the position search arrows become green (Fig.16a). When this is reached, press the pedal brake to stop the wheel.
- Fit the adhesive weight on the outer plane of the wheel **by hand at 12 o'clock position**.
- To find the position for the inner plane, turn the wheel until both the position search arrows become green. When this is reached, press the pedal brake to stop the wheel.
- Remove the automatic gauge and fit the adhesive weight in the pliers (e.g., 30 gr., Figure 16a) as shown in Fig.-15-.
- The weight correction position for the inner plane is indicated by horizontally positioned arrow in the center of the screen (Fig.-16a-)
- Move the gauge inside the rim in order to reach first position. When the corresponded horizontally positioned arrow becomes in green, fit the weight in the position where the weight pliers touch the wheel (Fig.-16-). The indication of the exact position of the weight is accompanied by a “beep” sound.
- The fact that the weight fitting position is no longer at 12 o'clock (Fig.-16-) is automatically offset.
- At the end of the procedure, the wheel balancing conditions can be checked by performing a trial spin.

The ALU-1 procedure is now completed.

10.5.3. STATIC BALANCING PROCEDURE

- Make sure the wheel is clean of any stones and/or mud.
- Remove any counterweights.
- Fit the wheel and make sure it is fastened properly
- From the initial display page (Fig.-1-), press  in order to enter wheel dimension page.
On this page (Fig.-2-), press the  in order to select  icon on the screen. The chosen icon's color becomes red. Then, press  in order to set it from Dynamic to Static (Fig.-17-).
- Determine the dimensions of the wheel using the automatic gauge provided
- After the data have been entered, close the protection guard to perform the automatic wheel spin.
- If the protection guard is already closed, press the  button to perform wheel spin manually.

Note : If you press  while the wheel guard is not closed (lowered), the program shows a warning page (Fig.-18-) and reminds you that you must close the wheel guard for wheel spin.

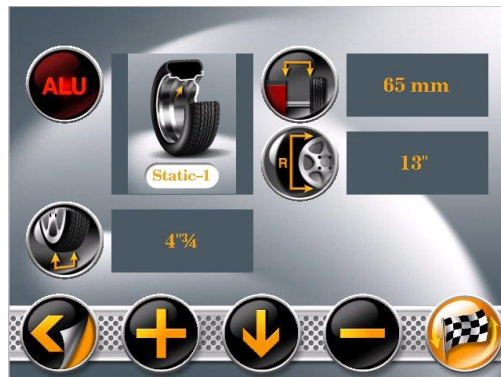
**Figure -17-**

**Figure -18-**

- In just a few seconds, the wheel runs at normal speed and the display screen shows wheel rotation (Fig.-19-)
- After the spin, the wheel stops automatically, taking into account the measured unbalance so that the fitting position of the outer weight is at about 12 o'clock. Open the wheel guard.
- The display unit indicates the direction in which to move the wheel to fit the weight and total weight needed to remedy unbalance (Fig.-20-)

**Figure -19-**

Figure -20-

- Turn the wheel in the direction indicated by the arrows until the correct position is achieved for correction of unbalance (arrow in green color). When this position is reached, press the pedal brake to stop the wheel.
- Remove the automatic gauge and fit the adhesive weight in the pliers as shown in Fig.-21-

**Figure -21-**

- Move the gauge inside the rim in order to reach the position. When the horizontally positioned arrow becomes in green, fit the weight in the position where the weight pliers touch the wheel. The indication of the exact position of the weight is accompanied by a “beep” sound.
- The fact that the weight fitting position is no longer at 12 o’clock, is automatically offset.
- At the end of the procedure, the wheel balancing conditions can be checked by performing a trial spin.
- The STATIC procedure is now completed.

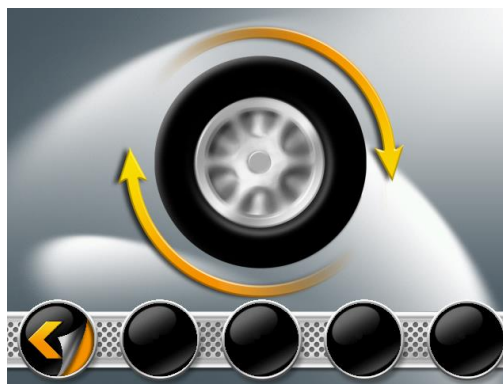
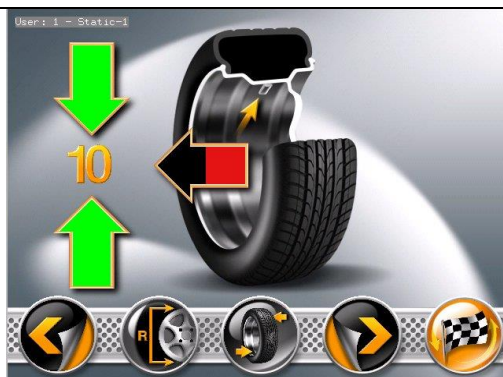
11. HIDDEN WEIGHT BEHIND SPOKES PROGRAM

This program is to be used for balancing alloy rim wheels with spokes if you wish to “hide” the weight, which has to be applied on the inner side.

This program also sub-divides the outside balancing weight into two weights, located in a concealed position behind two spokes on the aluminium rim.

Proceed to display the static or ALU-S unbalance measurements by performing a spin. (Fig.-22-)

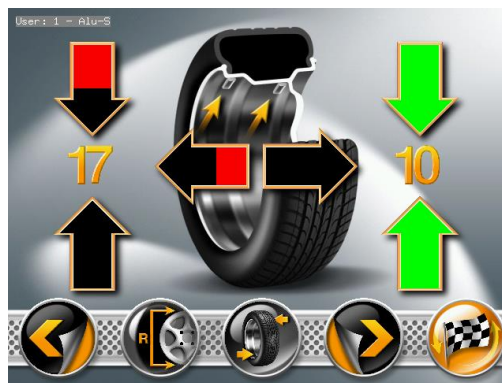



Figure -22-

Once the unbalance values have been determined, press button corresponding to the icon . At this point, the next row of buttons are displayed on the screen (Fig.-23-)

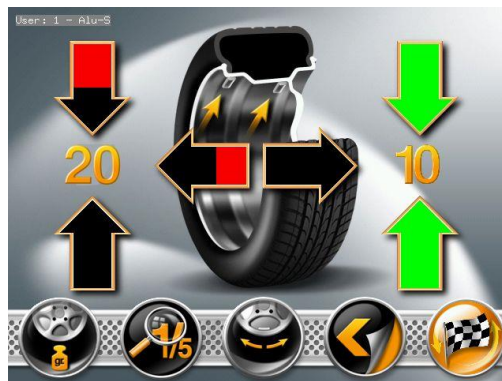
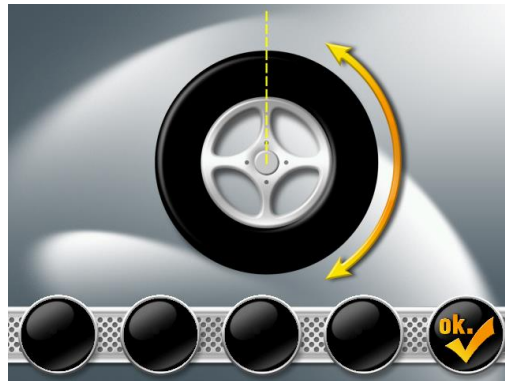



Figure -23-

Press the button corresponding to the icon . The program will display the screen in Fig.-24-

**Figure -24-**

Move any spoke up to 12 o'clock (in many cases, the position could already be behind or near one of the spokes) and press the button corresponding to the icon  or wait for 5 seconds for the automatic acquisition.

Enter the number of the spokes existing on the wheel (Fig.-25-) by turning the wheel back and forth until the desired value is achieved and press the button corresponding to the icon  or wait for 5 seconds for the automatic acquisition.

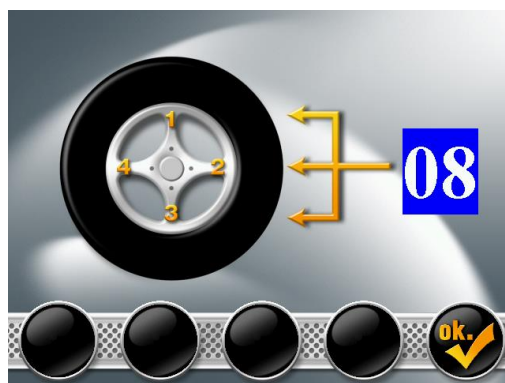
**Figure -25-**

The machine automatically calculates weight position in two parts hidden behind the spokes (Fig.-26-)

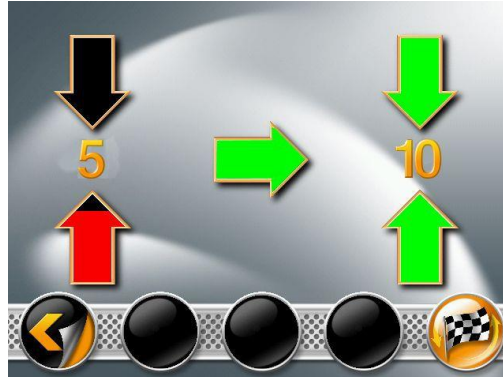
**Figure -26-**

Position the wheel correctly and stop the wheel with the pedal brake.

Fit the adhesive weight (in the example this is 10 g) in the automatic gauge as shown in Fig.-27-

**Figure -27-**

Fit the adhesive weight inside the spoke at the point indicated by horizontally positioned arrow (when becomes in green) (Fig.-26-). The indication of the exact position of the weight is accompanied by a “beep” sound.

Follow the same steps for the second weight (in the example this is 5 g).

Perform another trial spin.

Hidden weight procedure is completed.

12. RIM-TYRE OPTIMIZATION

The optimization procedure offsets strong unbalance, reducing the weight quantity to be fitted on the wheel to achieve balancing. This procedure permits reducing unbalance as much as possible by offsetting the tyre unbalance with that of the rim.

After displaying any unbalance measurement (Fig.-28-)

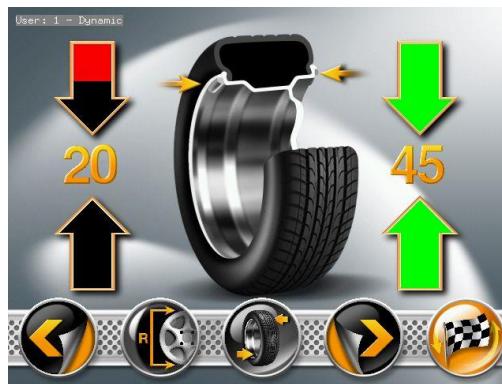



Figure -28-

Press the button corresponding to the icon  . At this point, the next row of buttons are displayed on the screen (Fig.-29-)



Figure -29-

Press the button corresponding to the icon  . The system displays the page in Fig.-30-. The display screen instructs to perform rim-tyre rotation.

**Figure -30-**

The optimization  operation can only be performed if the static unbalance is higher than 30 g. If it is less than this, the button relating to this operation is not displayed.

- Make a reference mark, using a piece of chalk for instance, of the position of the rim and tyre, remaining in line with the arrow on the flange, so as to be able to fit the rim back on in the same position.
- Remove the wheel from the wheel balancer.
- Remove the tyre and turn it on the rim by 180°.
- Fit the wheel back on the wheel balancer, positioning the reference mark on the rim in line with the arrow on the flange.
- Close the wheel guard. Make a second spin by pressing the button corresponding to the icon

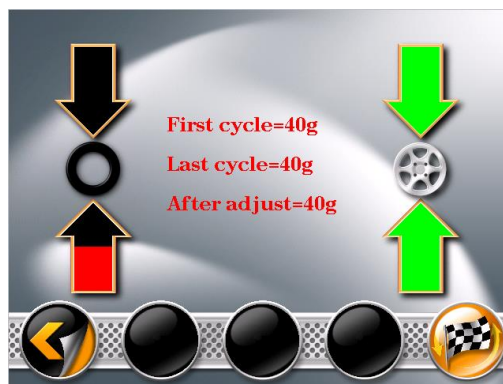

. After the spin, the following page appears on the screen (Fig.-31-)

**Figure -31-**

- Cancel the previously made reference marks.
- Position the wheel following to the arrows on the screen.
- When the arrow for tyre becomes green, make the first reference mark on the tyre at 12 o'clock position.
- When the arrow for rim becomes green, make the second reference mark on the rim at 12 o'clock position.
- Remove the wheel from wheel balancer.
- Remove the wheel and turn the tyre on the rim so the two marks coincide. The two coincided reference marks must be in line with the arrow on the flange.
- Press the button corresponding to the icon .

13. OPTIONS SETUP, UNIT OF MEASUREMENT

13.1. USER MENU FOR OPTIONS SETUP AND UNIT OF MEASUREMENT

Units of measurement such as unbalance weight can be shown in “grams” or “ounces”. The width and distance dimensions can on the other hand be shown in “inches” or “mm”.

Options such as automatic dimension gauge or wheel guard can be enabled or disabled from the same menu.

To change the units of measurement or setup options, on the initial page (Fig.-1-), press the button corresponding to the icon . The program will display the page in Fig.-32-

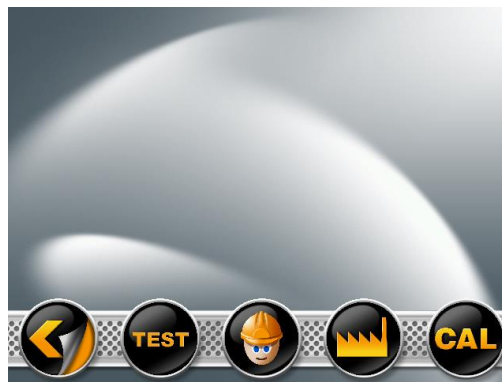



Figure -32-

Press the button corresponding to the icon  in order to enter user menu. The program will display the page in Fig.-33-

**Figure -33-**

Select the figure to be changed or set by pressing the button corresponding to the icon  (selected figure will be highlighted) and after that set/enable/disable it by pressing the button corresponding to the icon .

14. CALIBRATION

Calibration must be carried out in the following cases:

- ❑ on installation;
- ❑ when it is noted that the machine is not working perfectly;
- ❑ when the CPU board is replaced;

From the initial page (Fig.-1-), press the button corresponding to the icon . The program will display the page in Fig.-34-

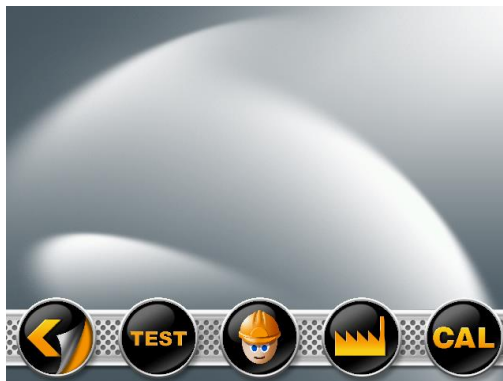





Figure -34-

Press the button corresponding to the icon  in order to enter calibration menu. The program will display the page in Fig.-35-



Figure -35-

ICON	DESCRIPTION
	Returns to previous page
	Mechanic system unbalance compensation
	Weight (gram) calibration
	Dimension gauge calibration
	Blank Function

14.1. WEIGHT (GRAM) CALIBRATION

- Fit a wheel of medium size, possibly balanced (13"-14" diameter).
- From the calibration page (Fig.-35-), press the button corresponding to the icon . The program will display the page in Fig.-36-



Figure -36-

- Press the button corresponding to the icon . The program will display the page in Fig.-37-. Carefully enter distance, diameter and wheel width measurements



Figure -37-



- Press the button corresponding to the icon  in order to confirm and turn back to calibration page (Fig.-36-).
- As shown in Fig.-36-, press the button corresponding to the icon  to perform a wheel spin without adding weights.
- After making the spin, the program will show Fig.-38-.





Figure -38-

- Fit 70g calibration weight on the outside of the wheel, **positioning the weight at 6 o'clock.**
- Press the button corresponding to the icon  to perform another wheel spin.
- After making the spin, the program will show Fig.-39-

**Figure -39-**

- Remove the 70g weight from the outside and fit it inside the wheel, as shown in Fig.-39-

IMPORTANT : Fit the 70g weight on the inner side in the same position as the outer side, **positioning the weight at 6 o'clock**

- Press the button corresponding to the icon  to perform another wheel spin.
- After making the spin, the program will show Fig.-40-
- Remove the 70g weight from the inside of the wheel and confirm by pressing the  button.

**Figure -40-**

- The calibration operation is now completed successfully.

14.2. MECHANIC SYSTEM UNBALANCE COMPENSATION

Mechanic system unbalance compensation must be carried out in the following cases:

- ❑ on installation;
- ❑ when it is noted that the machine is not working perfectly;
- ❑ when the CPU board is replaced;

The complete mechanic system (including the adapter) should be well-balanced. This balance operation for the mechanic system is normally done at factory.

On the other hand, sometime after, if any unbalance is determined on the mechanic system, thanks to the software, you can make the unbalance zero by electronic compensation.

In order to proceed with the operation, kindly follow the instructions below :





- Mount the adapter on the mechanic system.
- Enter the calibration page as described previously (Fig.-41-)

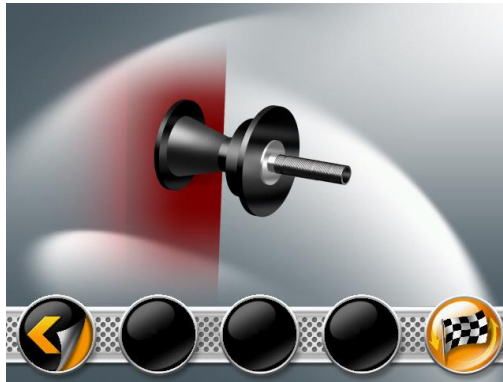

Figure -41-

- Press the button corresponding to the icon . The program will displays the page in Fig.-42-

**Figure -42-**

- As shown in Fig.-42-, press the button corresponding to the icon  to perform a spin without a wheel on the shaft.
- After making the spin, the program will show 180°.
- Enter the eccentricity angle that you would like to perform (Factory recommends 180°).
- Confirm by pressing the  button.
- Mount a wheel to the balancing machine and press .
- After the wheel balancer stops, dismount the wheel, turn it by your hand 180° on the balancing machine shaft, mount the wheel again and press .
- After making the spin, the program will show Fig.-43- Confirm by pressing the  button. Mechanic system unbalance compensation is now completed successfully.

**Figure -43-**

14.3. DISTANCE AND DIAMETER GAUGE CALIBRATION (SIRION LX & SIRION)





If you think that the distance-diameter dimension gauge is not working properly, it is possible to do a self-calibration for the gauge. You can calibrate distance and diameter separately.

- Enter the calibration page as described previously (Fig.-44-)

**Figure -44-**

- Press the button corresponding to the icon . The program will display the page in Fig.-45-

**Figure -45-**

ICON	DESCRIPTION
	Returns to previous page
	Calibration for distance parameter
	Calibration for diameter parameter
	Calibration for width parameter

14.3.1. CALIBRATION FOR DISTANCE

- On calibration page (Fig.-Z20), press the button corresponding to the icon . The program displays the page in Fig.-46-

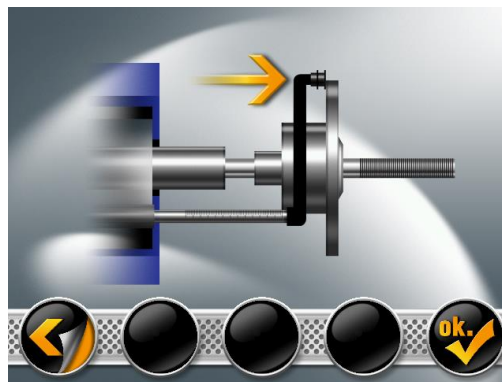

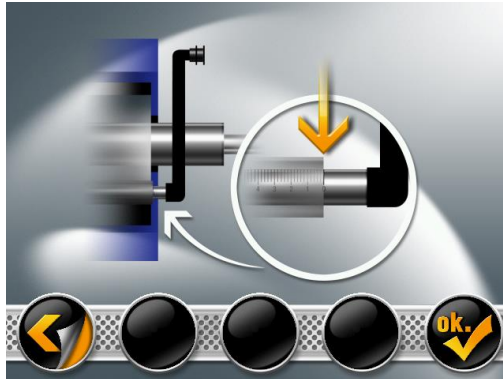

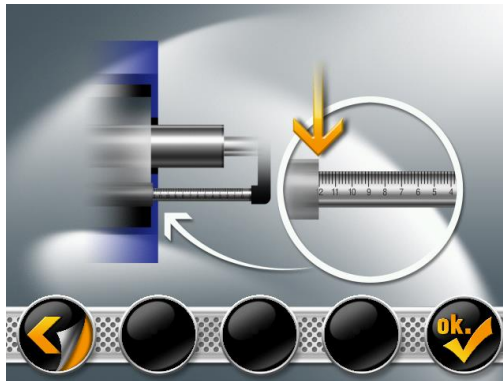



Figure -46-

- Move the gauge and touch it inside edge of the adaptor as shown and press 
- The program displays the Fig.-47-

**Figure -47-**

- Position the gauge to the “0” value indicated on the graduated bar, as shown, and press 
- The program displays the Fig.-48-

**Figure -48-**

- Position the gauge to the “12” value indicated on the graduated bar, as shown, and press 
- The program displays the Fig.-49-

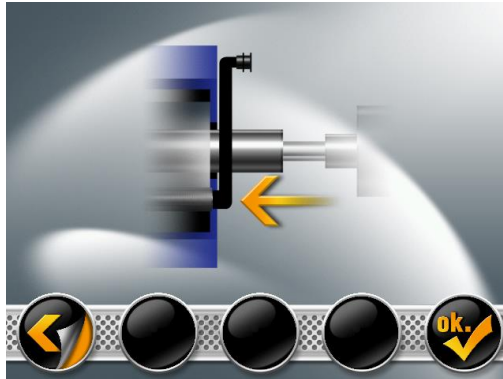
**Figure -49-**

- Position the gauge to its initial point, as shown, and press 
- The calibration procedure is now completed.



14.3.2. CALIBRATION FOR DIAMETER

- On calibration page (Fig.-50-), press the button corresponding to the icon .

**Figure -50-**

- The program displays the page in Fig.-51-

**Figure -51-**

- Fit a wheel of medium size (13"-15" diameter).
- Enter the same diameter (R) value by pressing  and .
- Move and touch the gauge to the upper edge of the rim, as shown, and press .
- The program displays the page in Fig.-52-

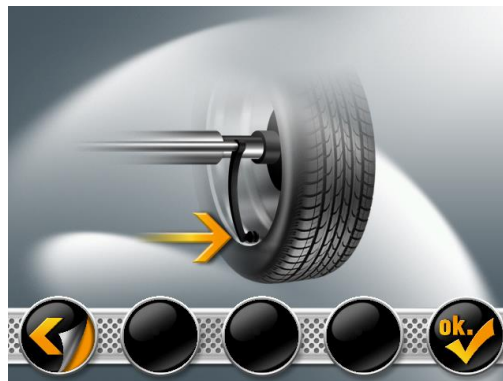
**Figure -52-**

- Move and touch the gauge to the lower edge of the rim, as shown, and press .
- The program displays the page in Fig.-53-

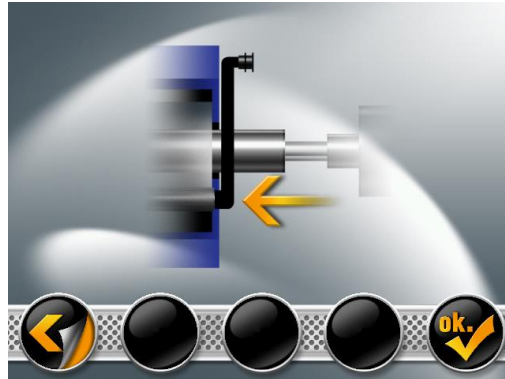
**Figure -53-**

- Position the gauge to its initial point, as shown, and press 
- The calibration procedure is now completed.

15. MAINTENANCE

WARNING!

Unplug the machine from power supply before any service or maintenance work.

To clean plastic panels or surfaces use alcohol (AVOID USING LIQUIDS CONTAINING SOLVENTS).

The display screen must be cleaned with a dry cloth; if it is very dirty, clean with a damp cloth and then dry.

Do not spray the alcohol directly on the control panel and do not clean using strong jets of compressed air.

16. BALANCING EQUIPMENT EFFICIENCY (Cones, Flanges, Adapters)

A wheel perfectly balanced, de-mounted and re-mounted in a different position, should show an unbalance of about 10 grams, depending on the type of wheel.

If the unbalance exceeds this limit check the equipment carefully and replace parts found in imperfect condition, wear, unbalance, etc.

There is another point to bear in mind.

If the centre hole of the rim is out-of-round, or not properly centred, balancing such wheels with the cone centring system will never give satisfactory results.

Therefore, those kinds of wheels can only be balanced by locking them on the shaft with their own rim holes. Irregularities in wheels may mean that a certain amount of unbalance remains when replaced on vehicle.

To overcome this kind of problem it is recommended that finishing balance is carried out with a finishing balancer.